













PROFILATI

Profiles

PROFILI SERIE

TE 60

ELENCO PROFILI SERIE TE60

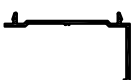
PROFILI	SIGLA	PESO gr/ml	UTILIZZAZIONE
	E 1001	1013	TELAIO
	E 1002	1093	TELAIO CON BATTUTA
	E 1003	1625	TELAIO 3 VIE CON COPRIFILO
	E 1004	824	ANTA SAGOMATA - vuoto 24 mm
	E 1005	822	ANTA ARROTONDATA - vuoto 24 mm
	E 1006	340	AGGANCIO CENTRALE
	E 1007	923	FASCIA
	E 1008	246	RIDUTTORE VETRO - vuoto 11 mm
	E 1009	181	ZANZARIERA - GOCCIOLATOIO
	E 1010	212	INCONTRO CENTRALE IV ANTA
	E 1011	601	PROFILO DI ACCOPPIAMENTO
	E 1013	1148	TELAIO ARROTONDATO CON BATTUTA
	E 1014	1191	TELAIO CON GOCCIOLATOIO E ZANZARIERA
	E 1016	312	BATTUTA A SCATTO PER TELAIO

ELENCO PROFILI SERIE TE60

PROFILI	SIGLA	PESO gr/ml	UTILIZZAZIONE
	E 1017	871	ANTA
	E 1018	1146	TELAIO CON GOCCIOLATOIO E ZANZARIERA
	E 1019	320	AGGANCIO CENTRALE
	CL 5103	1120	TELAIO DI ACCOPPIAMENTO
	TR 4034	211	RIDUTTORE VETRO
	E 1020	1008	TELAIO CON GOCCIOLATOIO E ZANZARIERA
	E 1021	676	PROFILO DI ACCOPPIAMENTO

scala 1:1

E 1001

1093 g/ml

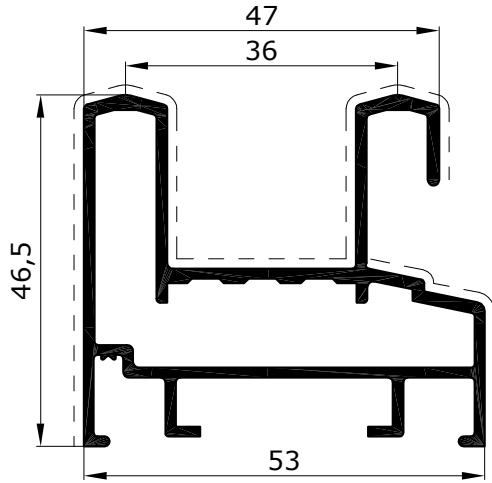

E 1002

1242 g/ml

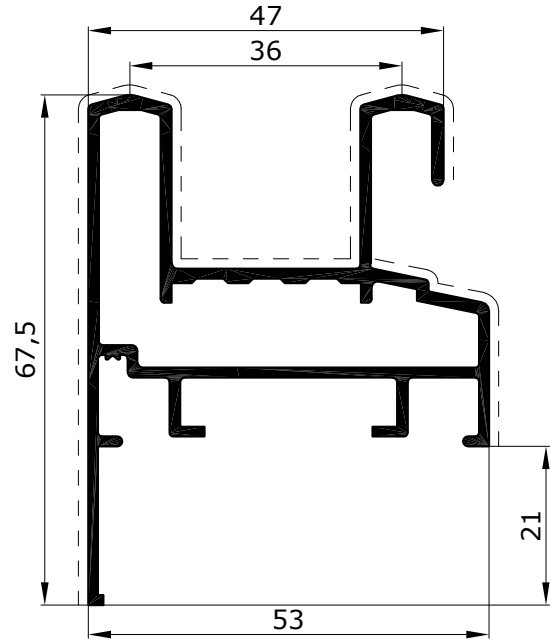

E 1003

1746 g/ml

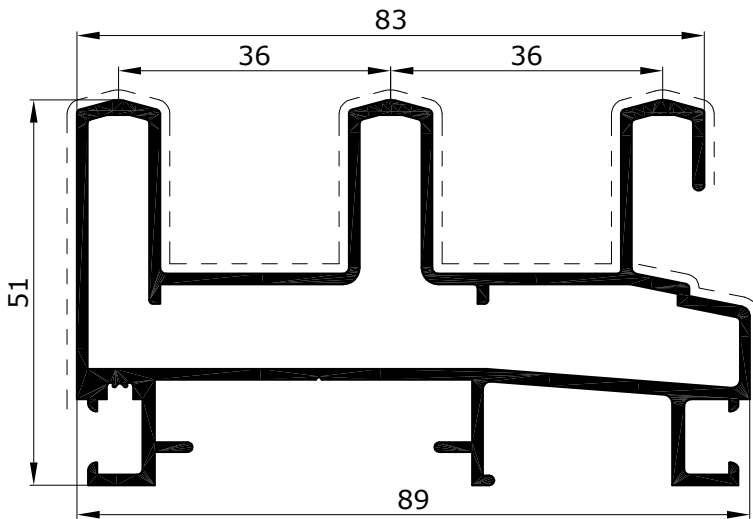

E 1014

1271 g/ml

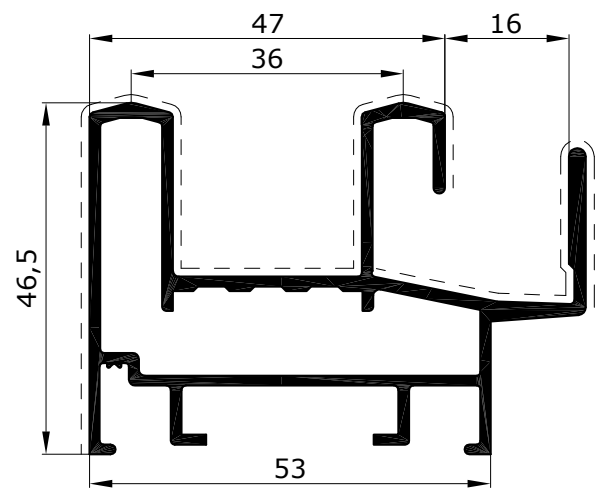

scala 1:1

E 1013

1148 g/m

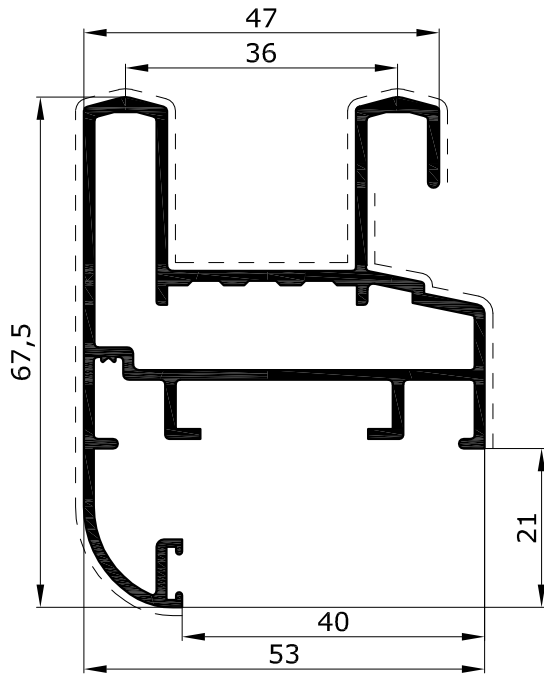

CL 5103

1120 g/ml

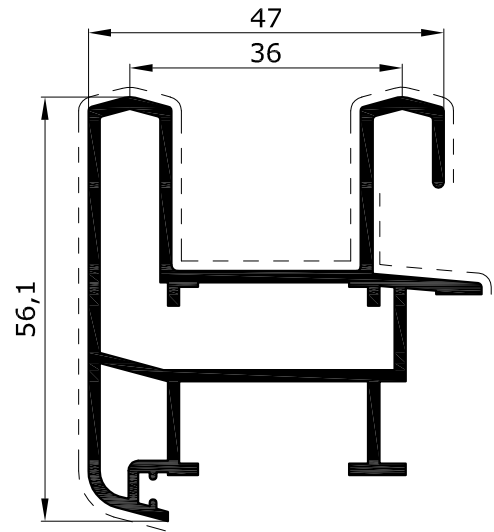

E 1018

1146 g/m

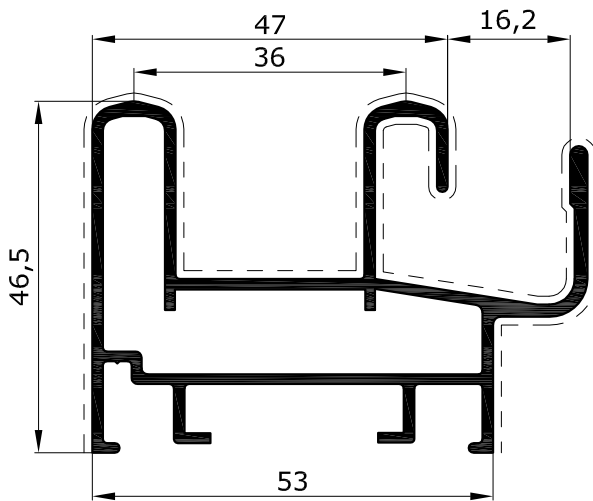

E 1020

1008 g/m

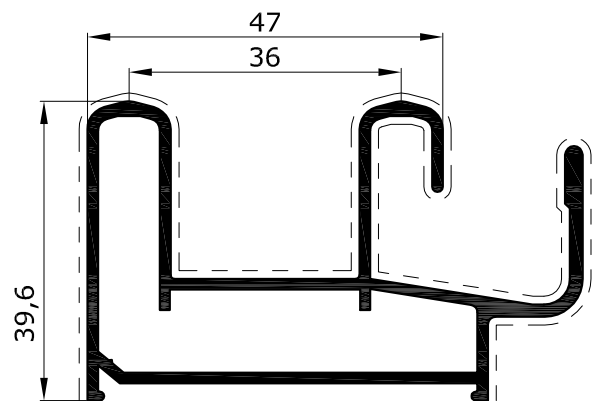

SERIE TE60

ANTA FERMAVETRO

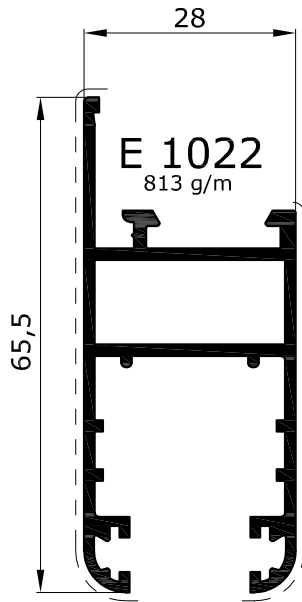

E 1023
144,2 g/m

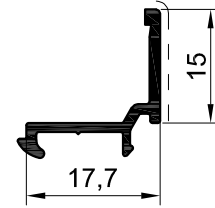

E 1024
214 g/m

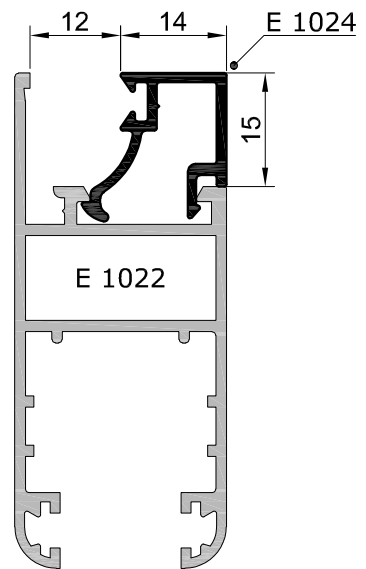
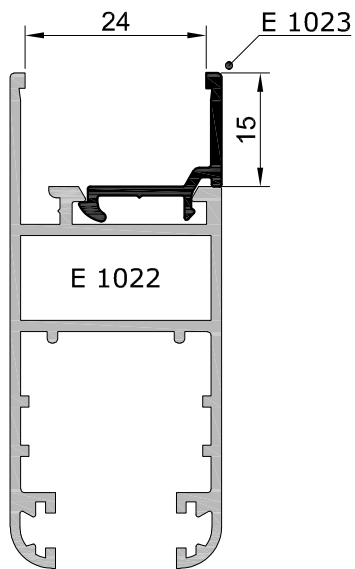
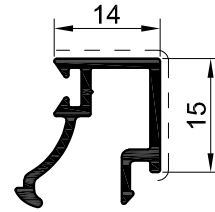

SERIE TE60

ANTE E FASCIA

scala 1:1

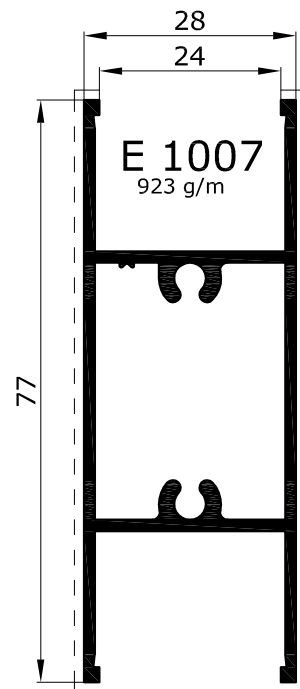
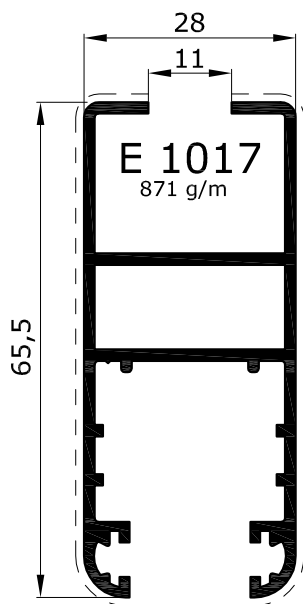
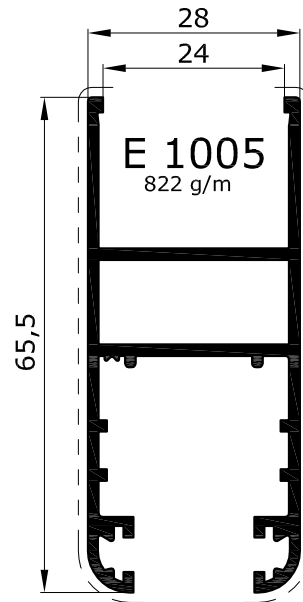
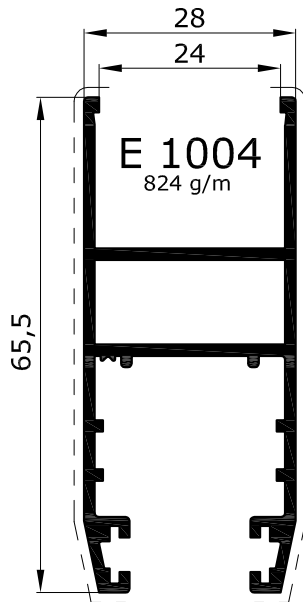

scala 1:1

